

Milling Inserts

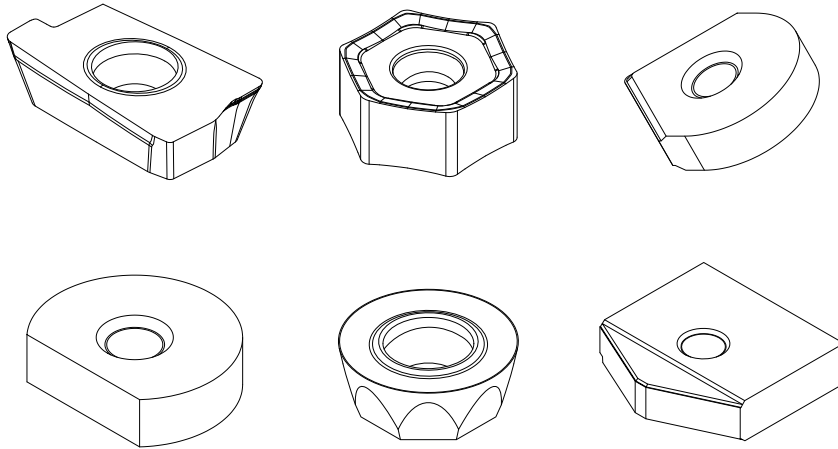

Turning Inserts



Threading Inserts
Parting & Grooving Inserts



Milling Inserts



Woodworking Inserts



Drilling Inserts



Circular Saw



Carbide Flats

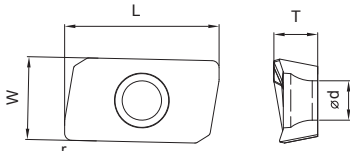

Milling Inserts

Milling Inserts

Shape	Style	Dimension (mm)					GEHM Grade	
		L	W	T	d	r	GU20	GM15
	APST1135PDER-H2	10.83	6.16	3.18	2.80	0.8	•	•
	APST1604PDER-H2	16.26	9.26	4.76	4.40	0.8	•	•
	APST1135PDER-M2A	10.83	6.16	3.18	2.80	0.8	•	•
	APST1604PDER-M2A	16.26	9.25	4.76	4.40	0.8	•	•
	APST1135PDER-GM	10.83	6.16	3.18	2.80	0.8	•	
	APST1604PDER-GM	16.26	9.25	4.76	4.40	0.8	•	

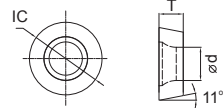

Milling Inserts

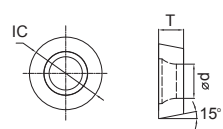
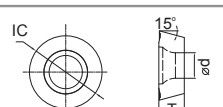
Shape	Style	Dimension (mm)			GEHM Grade	
		IC	T	d	GU20	GM15
	RPSW1003M0	10.00	3.18	4.40	•	•
	RPSW1204M0	12.00	4.76	4.40	•	
	RPST1204M0	12.00	4.76	4.40	•	•
	RDSW10T3M0	10.00	3.97	4.40	•	•
	RDSW1204M0T	12.00	4.76	4.40	•	•
	RDSW120400	12.00	4.76	4.40	•	
	RDSW1605M0T	16.00	5.56	5.50	•	
	RDST10T3M0	10.00	3.97	4.40	•	

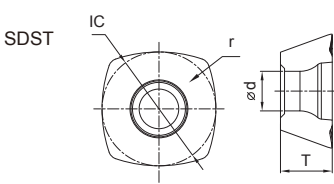

Fast Feed Milling Inserts

Shape	Style	Dimension (mm)				GEHM Grade	
		IC	T	d	r	GU20	
	SDST120512	12.70	5.56	4.4	1.2	•	
	SDST150512	15.875	5.56	5.5	1.2	•	

Face Milling Inserts

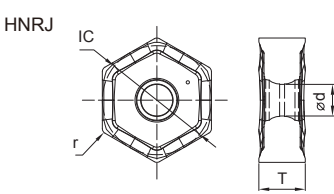
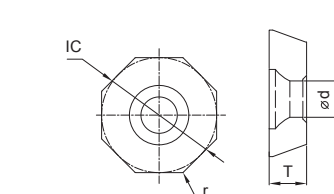
Shape	Style	Dimension (mm)				GEHM Grade		
		IC	T	d	r	GU25UF	GM15	GM25
	HNRJ060408	10.00	4.76	3.64	0.8	•		
	HNRX090608	16.00	6.35	5.00	0.8	•		
	OPRT160512	15.875	5.56	5.59	1.2			•
	ODRT040404	12.7	4.76	4.70	0.4		•	
	ODRT090308	9.525	3.18	3.56	0.8			•
	OERW060400	14.29	4.76	4.75	-			



Turning Inserts



Threading Inserts
Parting &
Grooving Inserts



Milling Inserts



Woodworking Inserts



Drilling Inserts



Circular Saw



Carbide Flats

On-edge Milling Inserts

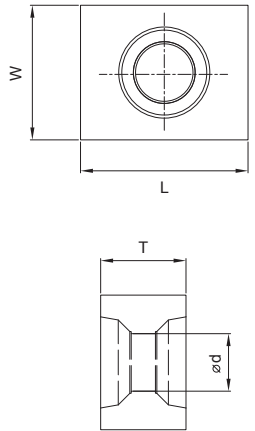
Shape	Style	Dimension (mm)				GEHM Grade		
		L	W	T	d	GK05	GU20	GM15
	LNRC120500	12.70	12.70	5.56	4.50	•		
	LNRC130600	12.70	12.70	6.35	5.20	•		
	LNRC150600	15.875	12.70	7.94	5.60	•		•
	LNRC150700	15.875	15.88	7.94	5.60	•		•
	LNRC190602	19.05	14.30	6.35	5.80			•
	LNRC250500	25.40	14.30	4.76	5.40	•		
	LNRC251200	25.40	15.88	12.70	6.50			•
	LNRC270902	27.90	15.60	9.52	5.70	•		
	LNRC280500	28.80	15.00	4.76	5.70		•	



Turning Inserts



Threading Inserts
Parting &
Grooving Inserts



Milling Inserts



Woodworking Inserts



Drilling Inserts



Circular Saw



Carbide Flats

Ball Milling Inserts

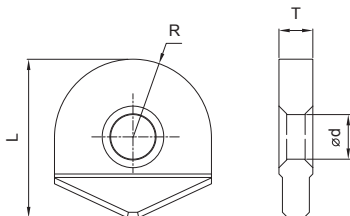
Shape	Style	Dimension (mm)			GEHM Grade
		R	T	d	GU25UF
	GFB-H10	5.00	2.70	4.00	•
	GFB-H11	5.50	2.70	4.00	•
	GFB-H12	6.00	3.20	5.00	•
	GFB-H13	6.50	3.20	5.00	•
	GFB-H16	8.00	4.20	5.00	•
	GFB-H17	8.50	4.20	5.00	•
	GFB-H20	10.00	5.20	6.00	•
	GFB-H21	10.50	5.20	6.00	•
	GFB-H25	12.50	6.20	6.00	•
	GFB-H26	13.00	6.20	6.00	•
	GFB-H30	15.00	7.20	8.00	•



Turning Inserts



Threading Inserts
Parting &
Grooving Inserts



Milling Inserts



Woodworking Inserts



Drilling Inserts



Circular Saw



Carbide Flats

Ball Milling Inserts

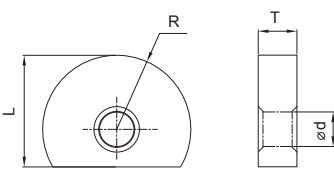
Shape	Style	Dimension (mm)			GEHM Grade	
		R	T	d	GU20	GU25UF
	GFB-D12	6.00	3.00	3.50	•	•
	GFB-D16	8.00	4.00	4.00	•	•
	GFB-D20	10.00	5.00	5.00	•	•
	GFB-D25	12.50	6.00	6.00	•	•
	GFB-D30	15.00	7.00	8.00	•	•

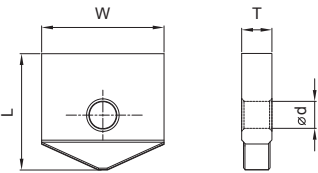

Ball Milling Inserts

Shape	Style	Dimension (mm)			GEHM Grade
		W	T	d	GU25UF
	SNHX-11	11.00	2.70	4.00	•
	SNHX-13	13.00	3.20	5.00	•
	SNHX-16	16.00	4.20	5.00	•
	SNHX-17	17.00	4.20	5.00	•
	SNHX-20	20.00	5.20	6.00	•
	SNHX-25	25.00	6.20	6.00	•
	SNHX-26	26.00	6.20	6.00	•
	SNHX-30	30.00	7.20	8.00	•

